

## LED Canopy Light – 100W

Model: RL-C100-A

Surface mount LED canopy lights are suitable for both outdoor and indoor commercial applications such as loading docks, petrol stations, freezers, cool rooms, food processing plants and common areas.

### Product Features

- Only consumes 100w of power
- Aluminium die cast housing
- Daylight & Microwave Motion Sensor
- Long operating life and performance
- 120° Beam Angle
- IP65 Waterproof housing

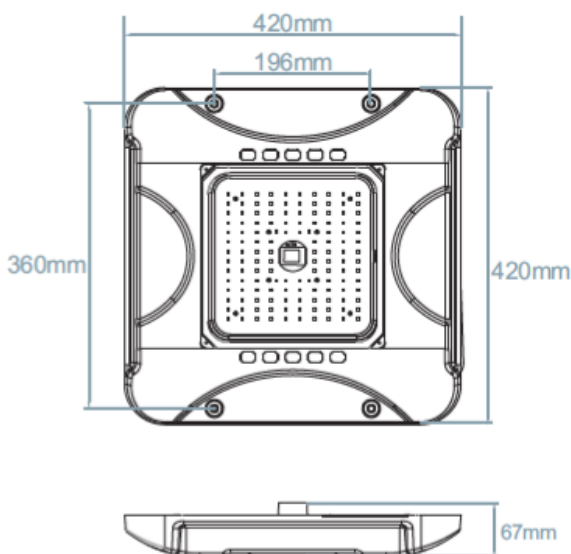
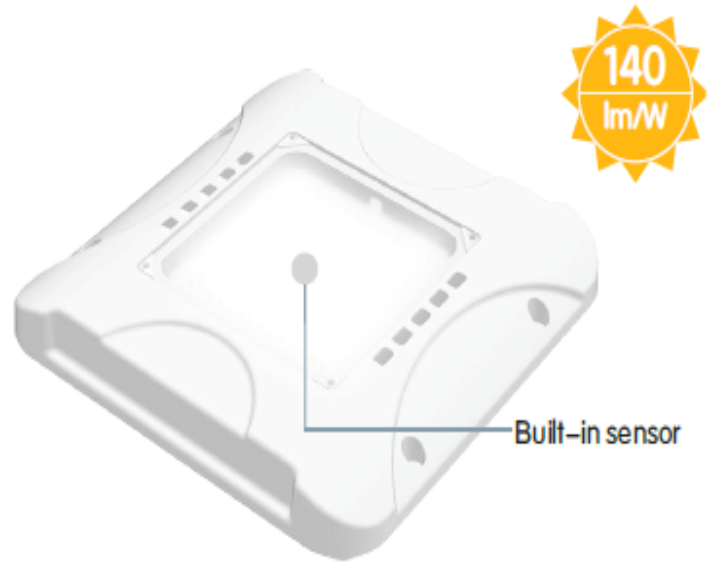

### SPECIFICATION

Colour	Cool White (5000K)
Lumen (lm)	14,000lm
LED Efficiency (Lm/w)	>140lm/w
Light Source	SMD LED's
CRI (%)	>80%
Beam Angle	120°
Power Requirement	AC 220~240V 50Hz
Power Consumption	100W
Housing	Die Cast Aluminium
Lifespan	> 40,000 hours
Operation Temperature	-20°C~+40°C
Dimension (mm)	420 ( L ) × 420 ( W ) × 67 ( D )
Weight	4.5kg
Sensor (option by remote)	Daylight & Microwave Motion Sensor
Warranty	5 years