

MultiFit LED Street Light – 100w

Model: RL-SL100W-2C-N or NS(silver housing)

LED Street lights are suitable for car parks, street lighting, lane ways, parks or anywhere external lighting is required. Our MultiFit Street Light is designed to fit either pole top mounting or spigot mounting all in the one product.







Product Features

1. 100w
2. 2 Colour Adjustable (4000K/5000K)
3. Black Housing
4. Fits 50~60mm spigot size
5. Quality Driver
6. Full range power input 90~305VAC
7. 10KV surge protector
8. Supports pole top (90° ±15°) or spigot mounting (0° ±15°)
9. 150/80° Beam Angle
10. IP65 Housing
11. IK08 Impact Rating
12. Weight 4.8kg

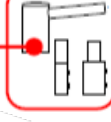

Options:

-  Silver Housing (no NEMA socket)
-  PE Cell (n/a in -N model)
-  Ø36-40mm Spigot Replacement (black only)
-  Mounting Poles
-  Outreach or Spigot Adaptors

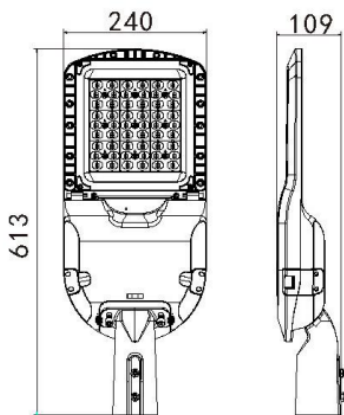
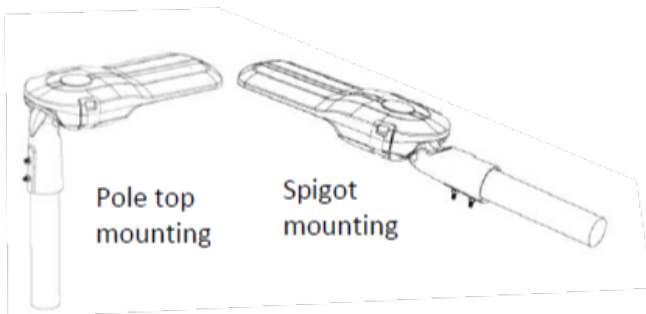

SPECIFICATION	
Colour Temp (2CCT)	4000K or 5000K (selectable)
Lumen (lm) 4000K	12566lm
Lumens (lm) 5000K	11256lm
Light Source	LED
Beam Angle	150° / 80°
Power Requirement	AC 90~305VAC
Power Consumption	95w
Housing	Aluminium with tempered glass diffuser
Lifespan	> 40,000 hours
Operation Temperature	-30°C~+40°C
Dimension (mm)	Spigot Mount: 613 (L) x 240 (W) x 109 (H)
Fits Spigot Size	Ø50 ~ Ø60mm
Protection Rating	IP65
Weight	4.8kg
Warranty	5 years